



2018

SERVICE



*Dalla Via Flaminia...
un'impresa che continua*



*Foto del decumanus minor Forum Sempronii,
tratto dell'antica Via Flaminia,
(parco archeologico di Fossombrone)
e statua dell'imperatore Claudio (Fano museo civico)*



- ITA** **TECNOLAM è un'azienda nata nel 1981.**
Nei primi anni la produzione principale era la lavorazione della lamiera per conto terzi, ma il richiamo alla produzione di prodotti finiti, ed in particolare di sistemi d'ordine per utensili divenne fortissima, anche perchè alcuni titolari provenivano da quel settore. Nel corso di questi 30 anni Tecnomlam è riuscita a divenire un'azienda leader nel settore dei sistemi d'ordine per utensili.
- Tecnomlam può contare oggi oltre 3000 clienti attivi in tutta Europa oltre a circa 200 punti vendita e concessionari.**
- TECNOLAM è una vera azienda produttrice con una strategia innovativa (composta da una serie di ditte ognuna specializzata a produrre un preciso articolo) in grado di competere con qualsiasi concorrente europeo o mondiale.**
- ENG** **TECNOLAM was founded in 1981.**
 During the first years the main production was the steel machining on behalf of third parties. Then the request of finished goods, and in particular of tools order systems became very strong, since some of Tecnomlam partners came from that sector. During these 30 years Tecnomlam has succeeded in becoming a leader company in the field of tools order systems.
- Nowadays Tecnomlam can count more than 3.000 active customers all over Europe, as well as about 200 selling points and concessionaires.
- TECNOLAM is a real manufacturing company with an innovating strategy (as it is composed of a series of companies, each one specialised in the production of a specific item) and it's able to compete with any competitor in Europe and in the World.
- FRA** **TECNOLAM est une société née en 1981.**
 Pendant les premières années la production principale était le travail de la tôle pour compte d'autrui, mais l'appel à la production des produits finis, et en particulière des systèmes de rangement pour l'outillage, était très fort, puisque quelques-uns des propriétaires de Tecnomlam venaient de ce secteur. Pendant ces 30 ans Tecnomlam a réussi à devenir une société leader dans le secteur des systèmes de rangement pour l'outillage.
- Tecnomlam aujourd'hui peut compter plus de 3.000 clients actifs dans l'Europe entière, et à peut près 200 revendeurs et concessionnaires.
- TECNOLAM est une vraie société productrice, avec une stratégie innovatrice (composée par une série de société chacune spécialisée pour la production d'un article spécifique) et en mesure de rivaliser avec n'importe quel concurrent Européen ou Mondiale.
- DE** **TECNOLAM ist eine Firma die im Jahr 1981 gegründet wurde.** In den ersten Jahren war die Verarbeitung von Blech auf Rechnung anderer die Hauptproduktion Tecnomlams, aber die Verlockung fertige Produkte, insbesondere Ordnungssysteme herzustellen war sehr stark, da manche Partnerinhaber von Tecnomlam aus diesem Sektor stammen. Im Laufe dieser 31 Jahre hat es Tecnomlam geschafft eins der führenden Unternehmen im Bereich der Ordnungssysteme zu sein.
- Sie kann heute über 4000 Kunden und etwa 200 Ausstellungspunkten in ganz Europa zählen.
- TECNOLAM ist ein Produktionsunternehmen mit einer innovativen Marktstrategie (sie ist aus mehreren Firmen zusammengestellt. Jede ist auf einen bestimmten Artikel spezialisiert) die im Stande ist mit jedem europäischen und weltweiten Mitbewerber zu konkurrieren.

MP3 è un pannello blu 1000x500 confezionato insieme ad una serie di accessori in plastica. L'imballo è realizzato in termoretraibile e foglio pubblicitario.

MP3 est un panneau bleu 1000 x 500 conditionné avec une série d'accessoires en plastique. L'emballage est fait en film thermorétractile et feuille publicitaire.

MP3 ist eine blaue Lochwand 1000x500 mit Zubehörteilen aus Plastik. Die Lochwand ist mit einem Werbeposter in einer angeschweißten Plastikfolie verpackt.

MP3 panel is a blue panel 1000x500 packed up together with a series of plastic accessories. The package is made of thermoretractable film and advertising sheet.

MP3 es un tablero azul 1000x500 confeccionado junto con una serie de accesorios de plástico. El embalaje ha sido realizado con material termo-retráctil y hoja publicitaria.

Panou de 1000x500 de culoare albastra; Pachetul contine un kit de 40 de carlige din plastic pentru scule diverse.

Art. Master Profi 3

1 prof. 10/10, 1.000 x 500 mm.

10 - Art. B01, 6 - Art. B02, 6 - Art. B03,

4 - Art. B04, 4 - Art. B05,

6 - Art. B06, 4 - Art. B10, tot. 40 Art. 4 Plugs

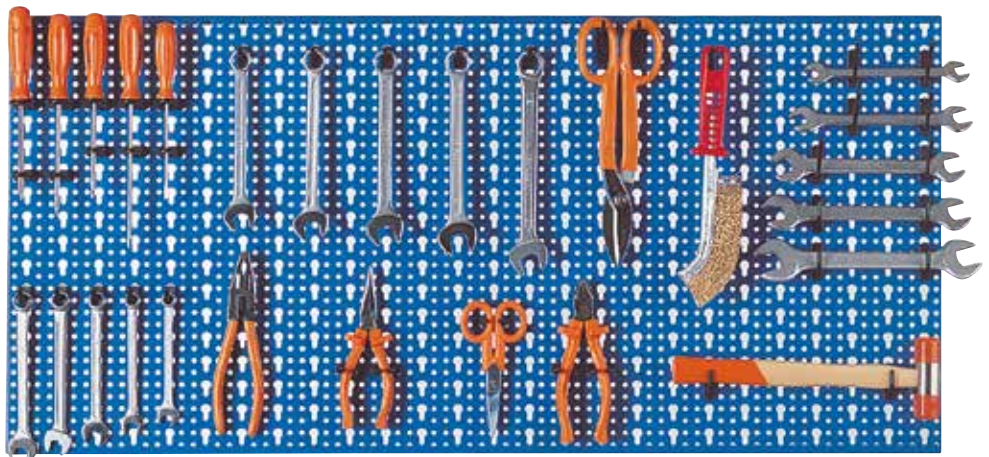

Cod. **010010002**

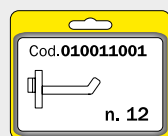

Art. **B01** blister

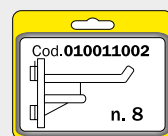

Art. **B02** blister

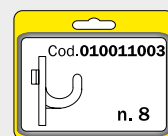

Art. **B03** blister

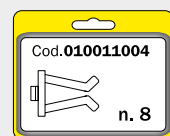

Art. **B04** blister

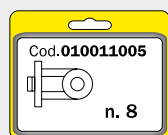

Art. **B05** blister

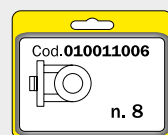

Art. **B06** blister

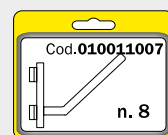

Art. **B10** blister

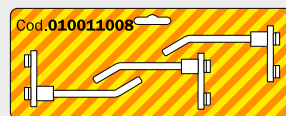

Art. **B02/10** blister



Art. **B02/20** blister



Art. **KONSOLLE**



Art. **B02/15** blister

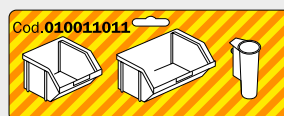

Art. **TRIS**



Art. **B12** blister

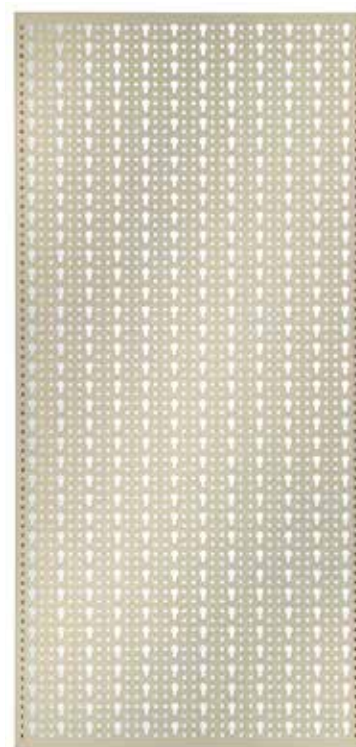

- Pannelli portautensili in lamiera d'acciaio verniciati con polveri epossidiche.
- Vasta gamma di accessori in plastica (Nylon e ABS)
- Panneaux porte-outils en tôle peinte avec poudre époxyde. Grande gamme d'accessoires plastiques. (Nylon et ABS)
- Steel plate tools-stand panels, painted with epoxy powder. Wide range of plastic accessories. (Nylon and ABS)
- Werkzeugwände aus Stahlblech, pulverbeschichtet. Grosse Auswahl an Zubehörteilen aus Plastik. (Nylon und ABS)
- Panel perforado para herramientas en chapa de acero lacada con pintura epoxi. Amplia gama de accesorios y soportes de plástico (Nylon y ABS)
- panouri perforate pentru scule de diferite dimensiuni ci culori din tabla vopsita cu vopsea pulbere anticoroziva;
- dispunem de o gama variata de carlige si accesorii pentru aceste.

Avorio/Sable
Ivory/Beige
Marfil/RO



Art. **Profi 500x1000** Cod. **010001002**
10/10 (box n.6)



Art. **B01**
(box n.200)

Cod. **010002001**



Art. **B07**
Trasparente/
Transparente (box n.40)

Cod. **010002012**



Art. **B02**
(box n.100)

Cod. **010002002**



Art. **B07/G**
Trasparente/
Transparente (box n.20)

Cod. **010002013**



Art. **B03**
(box n.100)

Cod. **010002003**



Art. **B08**
(box n.30)

Cod. **010002014**



Art. **B04**
(box n.100)

Cod. **010002004**



Art. **B12**
(box n.40)

Cod. **010002018**



Art. **B05**
(box n.100)

Cod. **010002005**



Art. **B02/10**
(box n.100)

Cod. **010002009**



Art. **B06**
(box n.100)

Cod. **010002006**



Art. **B02/15**
(box n.50)

Cod. **010002010**



Art. **B10**
(box n.100)

Cod. **010002007**



Art. **B02/20**
(box n.50)

Cod. **010002011**

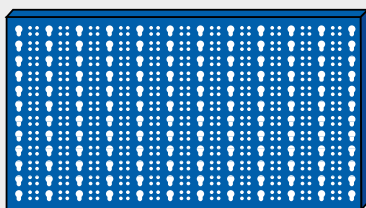

Azzurro/Bleu
Azzurro-blau/ Blue
Azul/Lichtblau
Cod. **010001001**

Avorio/Sable
Beige/Ivory
Marfil/Ivoor
Cod. **010001013**

Art. **Profi 1000x500**
10/10 (box n.6)

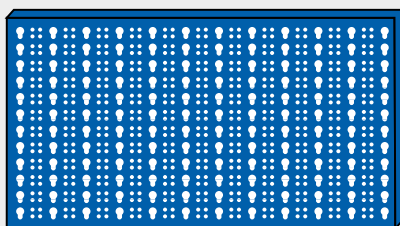

Azzurro/Bleu
Azzurro-blau/ Blue
Azul/Lichtblau

Art. **Profi 1000x850** 12/10 (box n.1) Cod. **010001064**

Art. **Profi 1500x850** 12/10 (box n.1) Cod. **010001065**

Art. **Profi 2000x850** 12/10 (box n.1) Cod. **010001066**

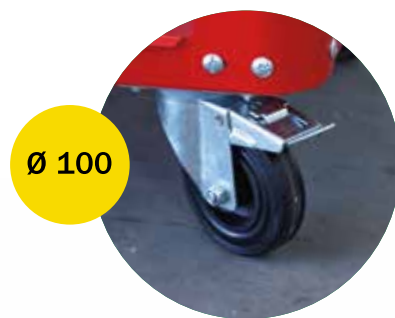

Carrello a tre ripiani smontabile colore rosso RAL 3000 bucciato con maniglione in ABS, tappeto sul ripiano superiore, due ruote fisse e due girevoli.

Dimensione utile del ripiano 450 x 755 mm con bordo H 40 mm.

Misure imballo 515x800x180 mm.

Servante à trois plans, démontable, peinte en rouge RAL 3000, grande poignée en ABS, tapis sur le plan supérieur, deux roues fixes et deux pivotantes. Dimension utile du plan 450x755 mm, bord 40 mm h.

Dimensions emballage: 515x800x180 mm.

3 shelf trolley, easy to dismantle, red RAL 3000 powder-coated with ABS handle, rubber carpet on the upper shelf and nr. 2 stiff + nr. 2 steerable wheels.

Availbe surface size 450x755 mm, edge H40 mm.

Packing dimensions: 515x800x180 mm

Werkstattwagen mit 3 Ablageflächen, abmontierbar, Farbe Rot RAL 3000 Orangenschale Bearbeitung mit ABS Handgriff. Matte auf der oberen Fläche, zwei befestigte Rollen und zwei schwenkbare. Nutzbare Flächenmaßen 450 x 755 mm mit Kante H 40 mm.

Verpackungsmaßen: 515 x 800 x 180 mm.

Carro con tres bandejas, desmontable, de color rojo (RAL 3000), con asa ergonómica en ABS, alfombra en la bandeja superior, dos ruedas fijas y dos ruedas giratorias.

Medida de las bandejas: 450 X 750 mm, con junta de goma H 40 mm.

Medida de embalaje: 515X800X180 mm.

Carucior cu 3 rafturi demontabil;
culoare rosu RAL 3000;
maner in ABS, covoras pe raftul superior;
2 roti fixe si 2 rotative;

Dimensiunile utile ale raftului sunt
450x755 mm;

Greutate portabila 70 kg.



Carlin S2

Cod. 010020404

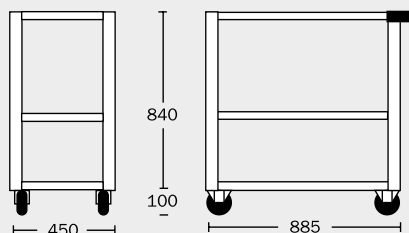

kg 17



Cod. **010020045**

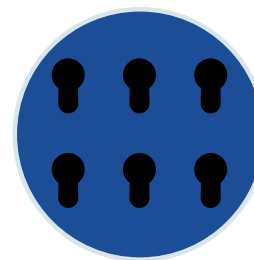
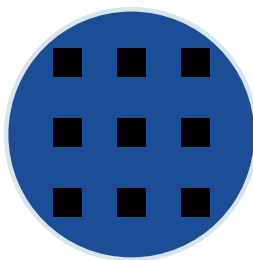

Cassetti accessoriati con sei divisori
 Maniglia autobloccante su ogni cassetto
 Chiusura centralizzata con chiave
 Accessori da acquistare a parte visibili in questa pagina

Tiroirs équipés de 6 séparateurs
 Poignée autobloccante sur chaque tiroir
 Fermeture centralisée à clé
 Accessoires en option illustrés sur cette page

Drawers equipped with 6 partitions
 Self-locking handle on each drawer
 Centralised key-lock shutting
 Optional accessories as shown in this page

Schubladen mit 6 Schubladenteiler versehen.
 Automatische Handgriffblockierung jeder Schublade.
 Zentralverriegelung mit Schlüssel
 Das auf der Abbildung zu sehende Zubehör kann man zusätzlich kaufen

Cajones equipados con seis divisorios
 Manija con bloqueo automático en cada cajón
 Cierre centralizado con llave
 Accesorios para comprar separados que se pueden ver en esta página

6 sertare pe glisiere cu extractie totala pe rulmenti sferici + 6 divizori metalici;
 maner autoblocant pe fiecare sertar pentru deschiderea involuntara;
 inchirere centralizata cu cheie;
 Construit din otel de calitate superioara, cu grosimea de 1.5 mm partea superioara si inferioara si 0.9 mm peretii laterali;
 4 roti din cauciuc plin negru; doua fixe pe ax, doua pivotante, din care una cu sistem de franare.

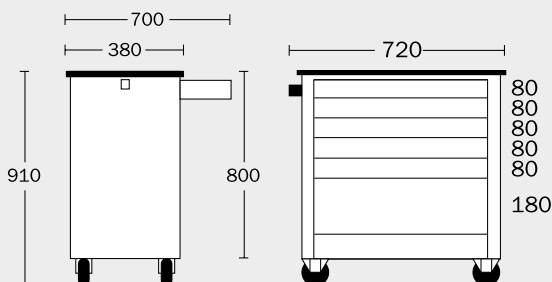

Cod. **010020366**

150 kg.

20 kg.

42 kg.

400x680x810 h



Chiusura centralizzata con chiave
 Dispositivo antiribaltamento che permette
 l'apertura di un solo cassetto alla volta
 Completo di accessori porta oggetti e
 porta rotolo di carta
 Sistema di bloccaggio garantito da due
 ruote girevoli munite di freno
 Ampio piano di appoggio ricoperto da
 termoformato in ABS.

Fermeture centralisée à clé
 Système antibasculement qui permet
 l'ouverture d'un seul tiroir à la fois
 Complet de porte-objet et porte-rouleau de papier
 Système de blocage assuré par deux
 roues pivotantes
 Large plan d'appui recouvert de thermoformé en ABS

Centralised key-lock
 Anti-tilting device which allows to open one
 drawer at time
 Equipped with glove box and paper roll holder
 Locking system provided by two rotating wheels
 Large support surface covered by thermoformed ABS

Zentralverriegelung mit Schlüssel
 Antikippmechanismus, dass die Oeffnung
 einer einzelnen Schublade nacheinander erlaubt
 Der Werkstattwagen ist mit Objekttraeger und
 Papierrollenhalter ausgestattet
 Blockierungssystem durch zwei schwenkbaren
 Rollen mit Bremsen
 Weite Ablageflaeche aus thermogeformtem ABS.

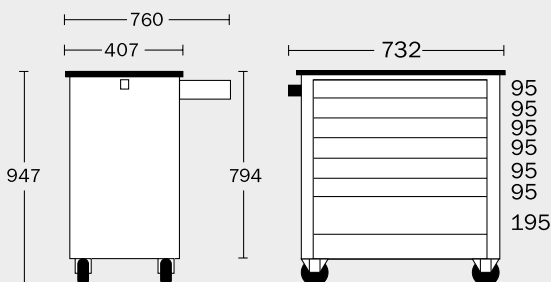

Cod. **010020393**

 150 kg.

 20 kg.

 42 kg.

 400x680x810 h



40 mm

Piana in faggio Buchen Holzplatte
Plateau hêtre Plancha de haya
Beech-wooden board Blat de fag

Art. LFE 1000 - Kg 20,00 - Cod. **010021050**

Art. LFE 1500 - Kg 30,00 - Cod. **010021051**

Art. LFE 2000 - Kg 40,00 - Cod. **010021052**



45 mm

Piana in faggio con ricopertura in gomma Rubber covered beech-wooden board
Plateau hêtre en caoutchouc Plancha de haya recubierta con goma
Buchen Holzplatte mit Gummimatte Blat de fag cu cauciuc

Art. LFE 1000/G - Kg 24,00 - Cod. **010021186**

Art. LFE 1500/G - Kg 36,00 - Cod. **010021187**

Art. LFE 2000/G - Kg 48,00 - Cod. **010021188**



30 mm

Piana in legno multistrati Mehrschicht-Holzplatte
Plateau bois multicouche Plancha contrachapada de madera
Wooden multilayer board Blat din lemn multistrat

Art. LE 1000 - Kg 12,00 - Cod. **010021008**

Art. LE 1500 - Kg 18,00 - Cod. **010021009**

Art. LE 2000 - Kg 21,00 - Cod. **010021010**



35 mm

Piana in legno multistrati con ricopertura in gomma Mehrschicht-Holzplatte mit Gummimatte
Plateau bois multicouche en caoutchouc Plancha contrachapada de madera recubierta con goma
Rubber covered wooden multilayer board Blat de lemn multistrat cu caucium

Art. LE 1000/G - Kg 16,00 - Cod. **010021180**

Art. LE 1500/G - Kg 22,00 - Cod. **010021181**

Art. LE 2000/G - Kg 29,00 - Cod. **010021182**



40 mm - 30/10

Piana in ferro zincato Verzinkte Stahlblech-Platte
Plateau fer zingue Plancha de hierro cincado
Zinc-plated iron board Blat din fier zincat

Art. FZ 1000 - Kg 28,00 - Cod. **010021014**

Art. FZ 1500 - Kg 41,00 - Cod. **010021015**

Art. FZ 2000 - Kg 54,00 - Cod. **010021016**



45 mm - 30/10

Piana in ferro zincato con ricopertura in gomma Rubber covered zinc-plated iron board
Plateau fer zingue en caoutchouc Plancha de hierro cincado recubierta con goma
Verzinkte Stahlblech-Platte mit Gummimatte Blat de fier zincat cu cauciuc

Art. FZ 1000/G - Kg 32,00 - Cod. **010021195**

Art. FZ 1500/G - Kg 47,00 - Cod. **010021196**

Art. FZ 2000/G - Kg 62,00 - Cod. **010021197**

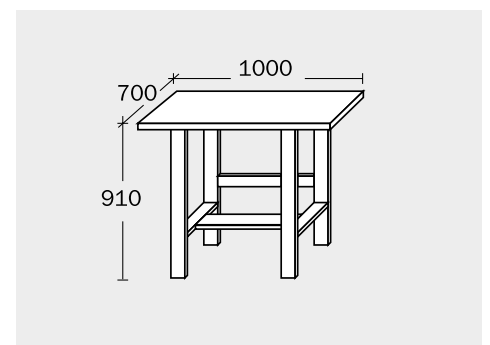

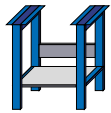

kg 21

Art.
SM 1000
Cod. **010021003**

Struttura composta da: 2 gambe banco + 4 traversini da 1000 mm

Structure composée par: 2 piéds + 4 traversines 1000 mm

Structure composed of: 2 bench legs + 4 sleepers 1000 mm

Grundgestell zusammengesetzt aus: 2 Fußgestellen + 4 Traversen zu 1000 mm

Estructura composta: 2 patas + 4 traversanos de 1000 mm

Structura pentru banc de 1000mm compusa din doua picioare+4 traverse din fier zincat de 1000

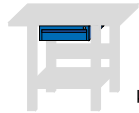

kg 7

Art.
Work 1
Cod. **010021006**
600x510x145H

Cassetto con guide scorrevoli e serratura

Tiroir avec coulisses et serrure

Drawer with ball bearing slides and lock

Schublade mit Kugelgelagerten Führungsschienen und Zylinderriegel.

Cajon con estructura metálica, guías correderas y cerradura

Casetiera cu un sertar cu extractie pe glisiere si inchidere cu cheie



kg 37

Art.
Work 3
Cod. **010021073**
420x615x565H

Cassetiera composta da 4 cassetti totalmente estraibili con divisori e serratura.

Meuble à tiroirs composé par 4 tiroirs totalement extractibles avec séparateurs et serrure centralisée.

Drawers-chest composed of 4 completely extractable drawers endowed with partitions and centralised lock

Schubladenschrank mit 4 Schubladen mit Vollauszug, Zentralverriegelung und mit Trennwinkel ausgestattet.

Cajonera con estructura metálica, 4 cajones totalmente extraíbles y con separadores metálicos y cerradura centralizada

Casetiera cu 4 sertare cu extractie totala cu divizori si inchidere centralizata

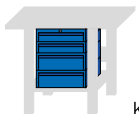

kg 55

Art.
Work 4
Cod. **010021081**
720x615x565H

Cassetiera composta da 4 cassetti totalmente estraibili con divisori e serratura.

Meuble à tiroirs composé par 4 tiroirs totalement extractibles avec séparateurs et serrure centralisée.

Drawers-chest composed of 4 completely extractable drawers endowed with partitions and centralised lock

Schubladenschrank mit 4 Schubladen mit Vollauszug, Zentralverriegelung und mit Trennwinkel ausgestattet.

Cajonera con estructura metálica, 4 cajones totalmente extraíbles y con separadores metálicos y cerradura centralizada

Casetiera cu 4 sertare cu extractie totala cu divizori si inchidere centralizata

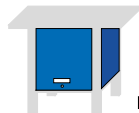

kg 27,5

Art.
Work 4 Free
Cod. **010021082**
720x615x565H

Fornito già montato, ha un piano intermedio di 350 mm. E' chiuso con una porta basculante dotata di serratura con chiave.

Livré déjà monté, il est doté d'une étagère intérieure de 350 mm de profondeur. Fermeture par une porte basculante à clé.

Delivered already assembled, it has an intermediate plane of 350 mm depth. Closing by a balancing door endowed with key-lock.

Schubladenschrank Work 4 free. Innen befindet sich eine Ablagefläche und wird geschlossen durch eine Klappentuer, welche eine Zylinderschlossverriegelung hat.

Enstructura en chapa interamente soldada y con estante central de 350 mm de profundidad. Se cierra por medio de una puerta basculante y su cerradura con llave.

Dulap cu o traversa metalica interna pentru scule; usa basculata cu inchidere cu cheie.

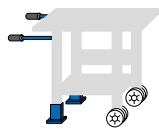

kg 4

Art.
1000-1500/S
Cod. **010021025**

Kit carrellato con ruote in nylon 2 regolatori d'altezza e maniglia

Set de roulettes avec roues en nylon, 2 régulateurs d'hauteur et poignée

Kit composed of nylon wheels, 2 height regulators and handle

Rollenset mit Nylonrollen, höhenverstellbaren Füßen und Handgriff.

Kit ruedas en nylon, 2 reguladores de altura y asa.

Kit cu manere si roti pentru bancul de 1000/1500; roti din plastic special si doua picioruse de inaltare pentru banc; greutate portanta a bancului pana la 700 kg.

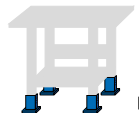

kg 2,4

Art.
1000-1500/K
Cod. **010021022**

Kit 4 regolatori d'altezza

Set régulateurs d'hauteur

Kit of 4 height regulators.

Höhenregler-Set mit 4 verstellbaren Füßen.

Kit 4 reguladores de altura.

Kit de 4 picioruse de reglare a inaltimii bancului

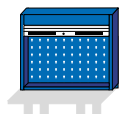

kg 29

Art.
Pratico 1000
Cod. **010021041**
1000x200x1000H

Armadio in lamiera dotato di serranda con serratura, pannello forato per fissaggio portautensili e Kit portautensili.

Armoire en tôle doté de rideau avec serrure. Panneau foré pour le fixation des porte-outils et set porte-outils.

Plate cabinet complete of shutter with lock, perforated panel to fix tools-stands and tools-stand kit

Werkzeugschrank aus Stahlblech mit verschließbarer Jalousie. Lochrückwand zur Werkzeuganbringung komplett mit Werkzeughalter-Set zur Ausstattung der Lochwand.

Armario de chapa con persiana y cerradura, panel cuelgaherramientas y kit portaherramientas

Dulap metalic cu jaluzea din aluminiu cu inchidere cu cheie; Panou perforat pentru fixarea sculelor; kit de 40 de carlige din plastic diverse+un pahar din plastic B08+un suport pentru burghie B12.

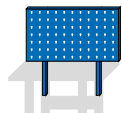

kg 11

Art.
1000/2SP + Kit acc. 1000
Cod. **010001058**
1000x850

Pannello Profi con 2 supporti + mensola da 1000 mm, 40 ganci assortiti, 1 bicchierino B08 e 1 portapunte B12

Panneau profi 1000x850 avec deux supports panneau + console de 1000 mm, 40 crochets assortis, 1 art. B08 et 1 porte-pointes B12

Profi panel 1000x850 with 2 panel brackets + 1 console 1000, 40 assorted hooks, 1 art. B08 and 1B12 drill-stand

Werkzeugwand Profi 1000x850 mit 2 Halterungen + Konsole zu 1000, 40 sortierten Kunststoffhaken, 1 Profibehälter B08 und 1 Bohrerhalter B12

Pannel PROFI 1000x850 con 2 soportes panel + estante de 1000 mm., 40 ganchos variados, 1 vasito B08 y 1 porta-puntas de taladro.

Panou perforat de 1000/850mm cu 2 suporturi pentru fixare pe banc+o tavita de 1000; kit de 40 de carlige din plastic diverse+un pahar din plastic B08+un suport pentru burghie B12.

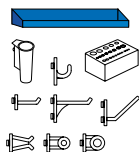

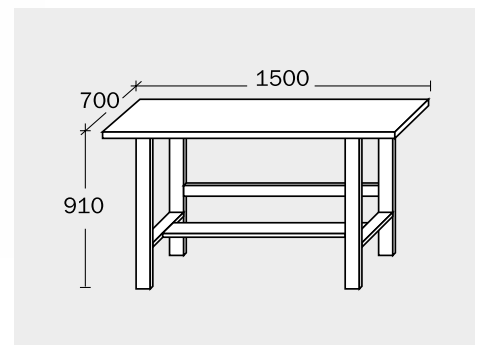

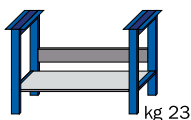

kg 23

Art.
SM 1500
Cod. **010021004**

Struttura composta da: 2 gambe banco
+ 4 traversini da 1500 mm

Structure composée par: 2 piéds
+ 4 traversines 1500 mm

Structure composed of: 2 bench legs
+ 4 sleepers 1500 mm

Grundgestell zusammengesetzt aus: 2 Fußgestellen
+ 4 Traversen zu 1500 mm

Estructura composta: 2 patas
+ 4 traversanos de 1500 mm

Structura pentru banc compusa din doua picioare
+4 traverse din fier zincat de 1500

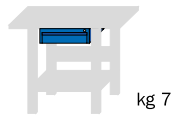

kg 7

Art.
Work 1
Cod. **010021006**
600x510x145H

Cassetto con guide scorrevoli e serratura

Tiroir avec coulisses et serrure

Drawer with ball bearing slides and lock

Schublade mit kugelgelagerten Führungsschienen und
Zylinderschloß.

Cajon con estructura metálica,
guías corredoras y cerradura

Casetiera cu un sertar cu extractie pe glisiere si
inchidere cu cheie



kg 37

Art.
Work 3
Cod. **010021073**
420x615x565H

Cassettiera composta da 4 cassetti totalmente estraibili
con divisorii e serratura.

Meuble à tiroirs composé par 4 tiroirs totalement
extractibles avec séparateurs et serrure centralisée.

Drawers-chest composed of 4 completely extractable
drawers endowed with partitions and centralised lock

Schubladenschrank mit 4 Schubladen mit Vollauszug,
Zentralverriegelung und mit Trennwinkel ausgestattet.

Cajonera con estructura metálica, 4 cajones totalmen-
te extraibiles y con separadores metalicos y cerradura
centralizada

Casetiera cu 4 sertare cu extractie totala cu divisorii si
inchirire centralizata

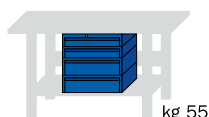

kg 55

Art.
Work 4
Cod. **010021081**
720x615x565H

Cassettiera composta da 4 cassetti totalmente estraibili
con divisorii e serratura.

Meuble à tiroirs composé par 4 tiroirs totalement
extractibles avec séparateurs et serrure centralisée.

Drawers-chest composed of 4 completely extractable
drawers endowed with partitions and centralised lock

Schubladenschrank mit 4 Schubladen mit Vollauszug,
Zentralverriegelung und mit Trennwinkel ausgestattet.

Cajonera con estructura metálica, 4 cajones totalmen-
te extraibiles y con separadores metalicos y cerradura
centralizada

Casetiera cu 4 sertare cu extractie totala cu divisorii si
inchirire centralizata

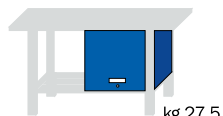

kg 27,5

Art.
Work 4 Free
Cod. **010021082**
720x615x565H

Fornito già montato, ha un piano intermedio di 350
mm. E' chiuso con una porta basculante dotata di
serratura con chiave.

Livré déjà monté, il est doté d'une étagère intérieure
de 350 mm de profondeur. Fermeture par une porte
basculante à clé.

Delivered already assembled, it has an intermediate
plane of 350 mm depth. Closing by a balancing door
endowed with key-lock.

Schubladenschrank Work 4 free.
Innen befindet sich eine Ablageflaeche
und wird geschlossen durch eine Klappentuer, welche
eine. Zylinderschlossverriegelung hat.

Enstructura en chapa interamente soldada y con
estante central de 350 mm de profundidad. Se cierra
por medio de una puerta basculante y su cerradura
con llave.

Dulap cu o traversa metalica interna pentru scule;
usa basculata cu inchidere cu cheie.

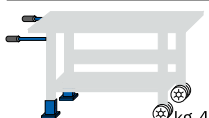

kg 4

Art.
1000-1500/S
Cod. **010021025**

Kit carrellato con ruote in nylon
2 regolatori d'altezza e maniglia

Set de roulettes avec roues en nylon, 2 régulateurs
d'hauteur et poignée

Kit composed of nylon wheels,
2 height regulators and handle

Rollenset mit Nylonrollen, höhenverstellbaren Füßen
und Handgriff.

Kit ruedas en nylon,
2 reguladores de altura y asa.

Kit cu manere si roti pentru bancul de 1000/1500;
roti din plastic special si doua picioruse de inaltare
pentru banc;
greutate portanta a bancului pana la 700 kg.



kg 2,4

Art.
1000-1500/K
Cod. **010021022**

Kit 4 regolatori d'altezza

Set régulateurs d'hauteur

Kit of 4 height regulators.

Höhenregler-Set mit 4 verstellbaren Füßen.

Kit 4 reguladores de altura.

Kit de 4 picioruse de reglare a inaltimii bancului

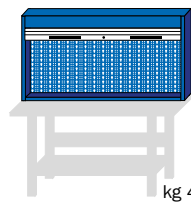

kg 41

Art.
Pratico 1500
Cod. **010021043**
1500x200x1000H

Armadio in lamiera dotato di serranda con serratura,
pannello forato per fissaggio portautensili e Kit
portautensili.

Armoire en tôle doté de rideau avec serrure. Panneau
foré pour le fixation des porte-outils et set porte-outils.

Plate cabinet complete of shutter with lock, perforated
panel to fix tools-stands and tools-stand kit

Werkzeugschrank aus Stahlblech mit
verschließbarer Jalousie. Lochrückwand zur Werkzeu-
ganbringung komplett mit Werkzeughalter-Set zur
Ausstattung der Lochwand.

Armario de chapa con persiana y cerradura, panel
cuelgaherra-
mientas y kit portaherramientas

Dulap metalic cu jaluzea din aluminiu cu inchidere cu cheie;
Panou perforat pentru fixarea sculelor;
kit de 40 de carlige din plastic diverse+un pahar din
plastic B08+un suport pentru burghie B12.

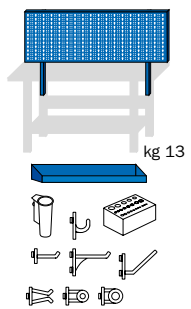

kg 13

Art.
1500/2SP +
Kit acc. 1500
Cod. **010001059**
1500x850

Pannello Profi con 2 supporti + mensola da 1500 mm,
60 ganci assortiti, 1 bicchierino B08 e 1 portapunte
B12

Panneau profi avec deux supports panneau
+ console de 1500 mm, 60 crochets assortis, 1 art.
B08 et 1 porte-pointes B12

Werkzeugwand Profi mit 2 Halterungen + Konsole zu
1500, 60 sortierten Kunststoffhaken,
1 Profibehälter B08 und 1 Bohrerhalter B12

Profi panel with 2 panel brackets + 1 console 1500,
60 assorted hooks, 1 art. B08 and 1B12 drill-stand

Pannel PROFI con 2 suportes panel + estante de 1500
mm., 60 ganchos variados, 1 vasito B08 y 1 porta-
puntas de taladro.

Panou perforat cu 2 suporti pentru fixare pe banc+o
tavita de 1500; kit de 60 de carlige din plastic
diverse+un pahar din plastic B08+un suport pentru
burghie B12.

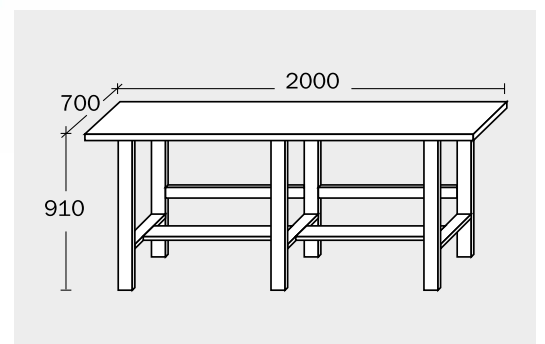

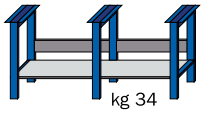

kg 34

Art. SM 2000
Cod. **010021005**

Struttura composta da: 3 gambe banco + 8 traversini da 1000 mm
Structure composée par: 3 piéds + 8 traversines 1000 mm
Structure composed of: 3 bench legs + 8 sleepers 1000 mm

Grundgestell zusammengesetzt aus: 3 Fußgestellen + 8 Traversen zu 1000 mm
Estructura composta: 2 patas + 4 traversanos de 1000 mm
Structura pentru banc de 2000mm compusa din trei picioare+8 traverse din fier zincat de 1000mm

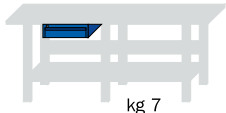

kg 7

Art. Work 1
Cod. **010021006**
600x510x145H

Cassetto con guide scorrevoli e serratura
Tiroir avec coulisses et serrure
Drawer with ball bearing slides and lock

Schublade mit kugelgelagerten Führungsschienen und Zylinderschloß.
Cajon con estructura metálica, guías correderas y cerradura
Casetiera cu un sertar cu extractie pe glisiere si inchidere cu cheie

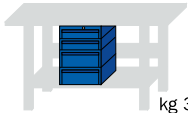

kg 37

Art. Work 3
Cod. **010021073**
420x615x565H

Cassetiera composta da 4 cassetti totalmente estraibili con divisori e serratura.
Meuble à tiroirs composé par 4 tiroirs totalement extractibles avec separateurs et serrure centralisée.
Drawers-chest composed of 4 completely extractable drawers endowed with partitions and centralised lock

Schubladenschrank mit 4 Schubladen mit Vollauszug, Zentralverriegelung und mit Trennwinkel ausgestattet.
Cajonera con estructura metálica, 4 cajones totalmente extraibiles y con separadores metalicos y cerradura centralizada
Casetiera cu 4 sertare cu extractie totala cu divizori si inchirere centralizata

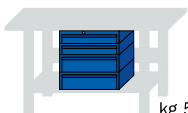

kg 55

Art. Work 4
Cod. **010021081**
720x615x565H

Cassetiera composta da 4 cassetti totalmente estraibili con divisori e serratura.
Meuble à tiroirs composé par 4 tiroirs totalement extractibles avec separateurs et serrure centralisée.
Drawers-chest composed of 4 completely extractable drawers endowed with partitions and centralised lock

Schubladenschrank mit 4 Schubladen mit Vollauszug, Zentralverriegelung und mit Trennwinkel ausgestattet.
Cajonera con estructura metálica, 4 cajones totalmente extraibiles y con separadores metalicos y cerradura centralizada
Casetiera cu 4 sertare cu extractie totala cu divizori si inchirere centralizata

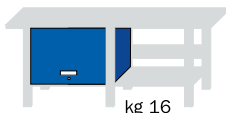

kg 16

Art. Work 4 Free
Cod. **010021082**
720x615x565H

Fornito già montato, ha un piano intermedio di 350 mm. E' chiuso con una porta basculante dotata di serratura con chiave.
Livré déjà monté, il est doté d'une étagère intérieure de 350 mm de profondeur. Fermeture par une porte basculante à clé.
Delivered already assembled, it has an intermediate plane of 350 mm depth. Closing by a balancing door endowed with key-lock.

Schubladenschrank Work 4 free.
Innen befindet sich eine Ablageflaeche und wird geschlossen durch eine Klappentuer, welche eine Zylinderschlossverriegelung hat.
Enstructura en chapa interamente soldada y con estante central de 350 mm de profundidad. Se cierra por medio de una puerta basculante y su cerradura con llave.

Dulap cu o traversa metalica interna pentru scule; usa basculata cu inchidere cu cheie.

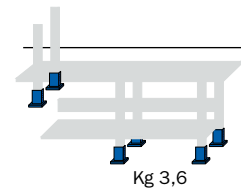

Kg 3,6

Art. 2000/K
Cod. **010021023**

Kit 6 regolatori d'altezza
Set régulateurs d'hauteur
Kit of 6 height regulators.

Höhenregler-Set mit 4 verstellbaren Füßen.
Kit 6 reguladores de altura.
Kit de 6 picioruse antivibrante pentru banc din cauciuc

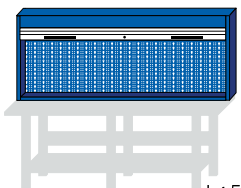

kg 54

Art. Pratico 2000
Cod. **010021045**
2000x200x1000H

Armadio in lamiera dotato di serranda con serratura, pannello forato per fissaggio portautensili e Kit portautensili.
Armoire en tôle doté de rideau avec serrure. Panneau foré pour le fixation des porte-outils et set porte-outils.
Plate cabinet complete of shutter with lock, perforated panel to fix tools-stands and tools-stand kit

Werkzeugschrank aus Stahlblech mit verschließbarer Jalousie. Lochrückwand zur Werkzeuganbringung komplett mit Werkzeughalter-Set zur Ausstattung der Lochwand.

Armario de chapa con persiana y cerradura, panel cueigaherramientas y kit portaherramientas

Dulap metalic cu jaluzeza din aluminiu cu inchidere cu cheie; Panou perforat pentru fixarea sculelor; kit de 80 de carlige din plastic diverse+un pahar din plastic B08+doua suporturi pentru burghie B12.

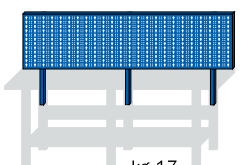

kg 17

Art. 2000/3SP + 2Kit acc. 1000
Cod. **010001060**
2000x850

Pannello Profi con 3 supporti + mensola da 2000 mm, 80 ganci assortiti, 1 bicchierino B08 e 1 portapunte B12

Panneau profi 2000x850 avec deux supports panneau + console de 2000 mm, 80 crochets assortis, 1 art. B08 et 1 porte-pointes B12

Profi panel 2000x850 with 3 panel brackets + 1 console 2000, 80 assorted hooks, 1 art. B08 and 1B12 drill-stand

Werkzeugwand Profi 2000x850 mit 3 Halterungen + Konsole zu 2000, 80 sortierten Kunststoffhaken, 1 Profibehälter B08 und 1 Bohrerhalter B12

Pannel PROFI 2000x850 con 3 soportes panel + estante de 2000 mm., 80 ganchos variados, 1 vasito B08 y 1 porta-puntas de taladro.

Panou perforat de 2000/850mm cu 3 suporturi pentru fixare pe banc+o tavita de 2000; kit de 80 de carlige din plastic diverse+un pahar din plastic B08+un suport pentru burghie B12.

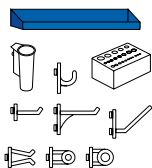



Tecnolam srl

Via Flaminia, 2/B - Calcinelli
61036 Colli al Metauro (PU)
Tel. +39 0721 876010
Fax +39 0721 876012

www.tecnolamweb.com
info@tecnolamweb.com

Sc Tecnolam-Ro Srl

Loc. Izvin nr. 15 - biroul, 1
307343 Judetul Timisoara (RO)
Tel. +40 371408854
Fax +40 256332599

www.tecnolam.ro
office@tecnolam.ro

Tecnolam France

Tel. 0474956354
Fax 0474956362

Tecnolam Deutschland

Tel. 08001830290
Fax +39 0721 876012